

M O R N I N G

Morning Machine MM-730

User Manual

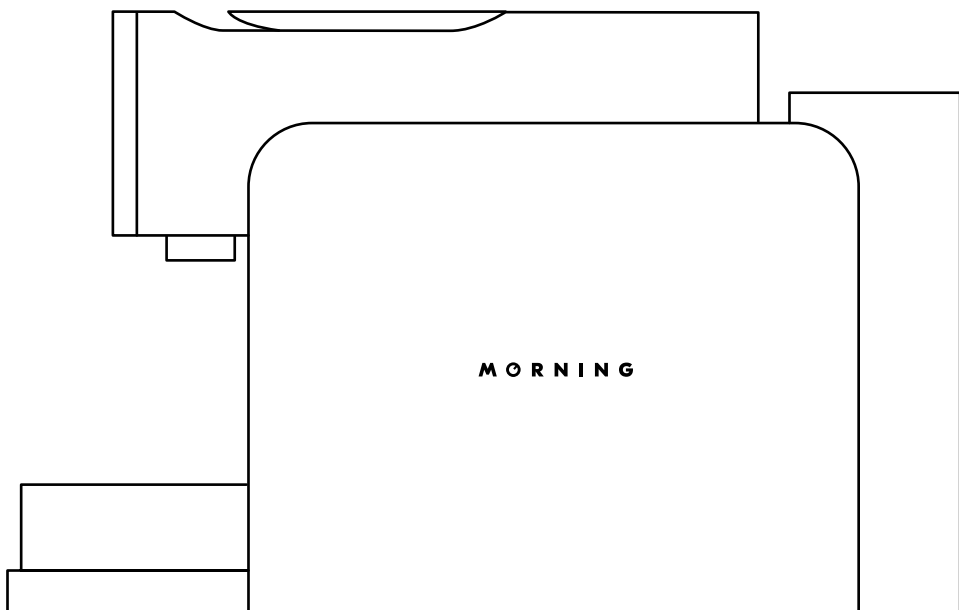

Contents

4	Safety Precautions
7	What's In The Box
8	Machine Overview
9	Morning Machine Dial
11	Morning Machine Setup
13	Brewing Your First Cup
17	Compatible Capsule Types
18	Brewing Tips
19	Pairing With The Morning Mobile App
22	Brewing A Roaster Recipe
23	Creating Your Own Recipes
23	Eco Mode
24	Cleaning and Maintenance
27	Troubleshooting
29	Technical Specifications
30	Reset Machine Settings
31	Warranty Information

Safety Precautions

- This product may become a safety hazard if these instructions and safety precautions are ignored.
- In the event of an emergency: Immediately remove the plug from the power socket.
- This product is intended for household and similar use only. The manufacturer accepts no responsibility, and the guarantee will not apply in the event of any commercial use, inappropriate use or failure to comply with the instructions.
- Before cleaning, unplug the product and let it cool down. Never clean with a wet cloth or immerse plug, cord or product in any liquids.
- This product can be used by children aged 8 years and above if they have been given supervision or instruction concerning the product's use safely and if they understand the hazards involved.
- Cleaning and user maintenance shall not be made by children aged 8 years and above and are supervised. Keep the product and the power cord out of reach of children aged less than 8 years.
- This product can be used by the person with reduced physical, sensory or mental capabilities. Inexperience and under knowledge people are allowed if they have been given supervision or instruction concerning use of the product in a safe way and understand the hazards involved.
- Do not insert fingers into the capsule compartment and capsule shaft, as there is a danger of injury.
- Do not use the product without the drip tray and drip grid.
- Keep the product/cord out of reach of children.
- Do not fill the water tank with hot water.
- Do not immerse the Machine in liquids—the risk of electric shock.
- Only use capsules intended for this product. If the capsule does not fit, do not force the capsule into the product.
- **⚠ WARNING:** To avoid the risk of injury, do not open the brew chamber during the brewing process.
- Check that the voltage quoted on the rating plate is the same as your voltage.
- Connect the product to earthed power sockets only. An improper connection voids warranty. Remove plug from the socket if not in use for a long time.
- Do not place the power cord near hot parts or sharp objects, etc.
- Never touch the cord with wet hands. Do not unplug by pulling the cord.
- Do not hang the power cord as there is a danger of tripping. If it is damaged, do not use the product. To avoid any hazards, only allow Morning (Akronym Pte Ltd) to repair the product and replace the power cord.
- Do not attempt to open the product or insert anything into the openings.
- All actions other than regular use, cleaning and care must be performed by Morning (Akronym Pte Ltd). Unauthorised maintenance voids warranty.
- Do not use the product if it is not in perfect working condition or evidence of damage. In such cases inform Morning (Akronym Pte Ltd).
- Place on a flat, stable and heat-resistant work surface away from water splashes and any heat sources.
- Packaging materials (plastic bags etc.) are recyclable and are potential hazards. Keep them out of reach of children.
- This product should not be disposed of with other household wastes throughout the EU. To prevent possible harm to the environment or human health from uncontrolled waste disposal, recycle it responsibly to promote the sustainable reuse of material resources.
- It is strongly suggested that the Machine be placed evenly on a stable, secure and heat-resistant surface.
- Children shall not play with the appliance.
- The instructions for appliances normally cleaned after use, and not intended to be immersed in water for cleaning, shall state that the appliance must not be immersed and state that the coffee-maker shall not be placed in a cabinet.
- This appliance is intended to be used in household and similar applications such as:
 - staff kitchen areas in shops, offices and other working environments;
 - farmhouses;
 - by clients in hotels, motels and other residential type environments; – bed and breakfast type environments.
- Never leave the product unattended during operation.
- Do not use the product if it is damaged, has been dropped or not operating correctly. Immediately remove the plug from the power socket. Contact Morning (Akronym Pte Ltd) or Morning (Akronym Pte Ltd) authorised representatives for examination, repair or adjustment.
- A damaged product can cause electrical shocks, burns and fire.
- Always completely close the lever and never lift it during operation. Scalding may occur.
- Do not put fingers under the coffee and water outlet, as there is a risk of scalding.
- Water could flow around a capsule when not perforated by the blades and damage the product.
- Never use an already used, damaged or deformed capsule.
- If a capsule is blocked in the capsule compartment, turn the Machine off and unplug it before any operation. Call Morning (Akronym Pte Ltd) or Morning (Akronym Pte Ltd) authorised representative.
- Always fill the water tank with fresh drinking water.
- Empty water tank if the product will not be used for an extended time (holidays, etc.).
- Replace water in the water tank when the product is not operated for more than a week.
- Do not use the product without the drip tray, unless using a tall mug/cup to avoid spilling any liquid on surrounding surfaces.
- Do not use any strong cleaning agent or solvent cleaner. Use a damp cloth and mild cleaning agent to clean the surface of the product.
- When unpacking the Machine, remove the plastic film and dispose of.
- Morning (Akronym Pte Ltd) reserves the right to change instructions without prior notice.

What's In The Box

RoHs						
	Pb	Hg	Cd	Cr(VI)	PBBs	PBDEs
Plastic enclosure and chassis	<input type="radio"/>	<input type="radio"/>	<input type="radio"/>	<input type="radio"/>	<input type="radio"/>	<input type="radio"/>
Motors/Valves	<input type="radio"/>	<input type="radio"/>	<input type="radio"/>	<input type="radio"/>	<input type="radio"/>	<input type="radio"/>
Printed circuit board assembly	<input type="radio"/>	<input type="radio"/>	<input type="radio"/>	<input type="radio"/>	<input type="radio"/>	<input type="radio"/>
Cable and wire	<input type="radio"/>	<input type="radio"/>	<input type="radio"/>	<input type="radio"/>	<input type="radio"/>	<input type="radio"/>
Metal parts/ Heating module	<input type="radio"/>	<input type="radio"/>	<input type="radio"/>	<input type="radio"/>	<input type="radio"/>	<input type="radio"/>

O: The content of such hazardous substance in a certain homogenous materials of such component is below the limit required by RoHS 3 (EU 2015/863)

X: The content of such hazardous substance in a certain homogenous materials of such component is beyond the limit required by RoHS 3 (EU 2015/863)

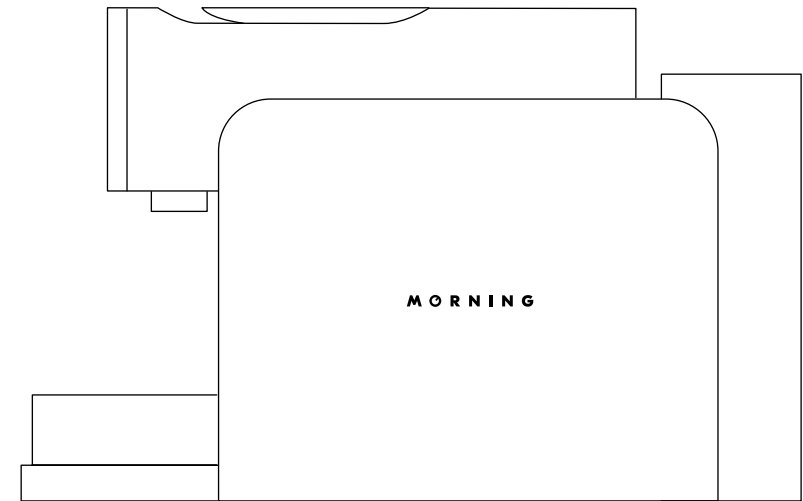

The Morning Machine

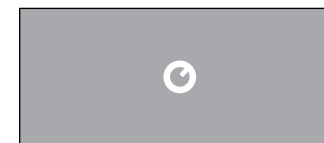

Quick Start Guide

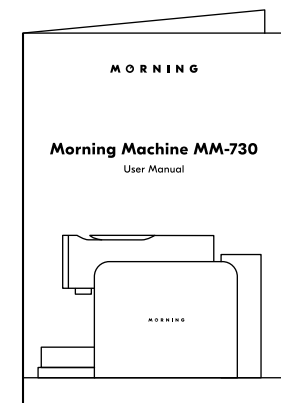

User Manual

Machine Overview

- A** Dial Control
- B** OLED Screen
- C** Back Button
- D** Confirm Button
- E** Lever
- F** Capsule Slot
- G** Coffee Outlet
- H** Water By-pass Outlet
- I** LED Light
- J** Used Capsule Container (8-10 Capsules)
- K** Used Capsule Drip Base
- L** Drip Tray
- M** Drip Tray Cover
- N** Silicone Tray (For Scale)
- O** Scale
- P** Water Tank & Lid
- Q** Power Cord

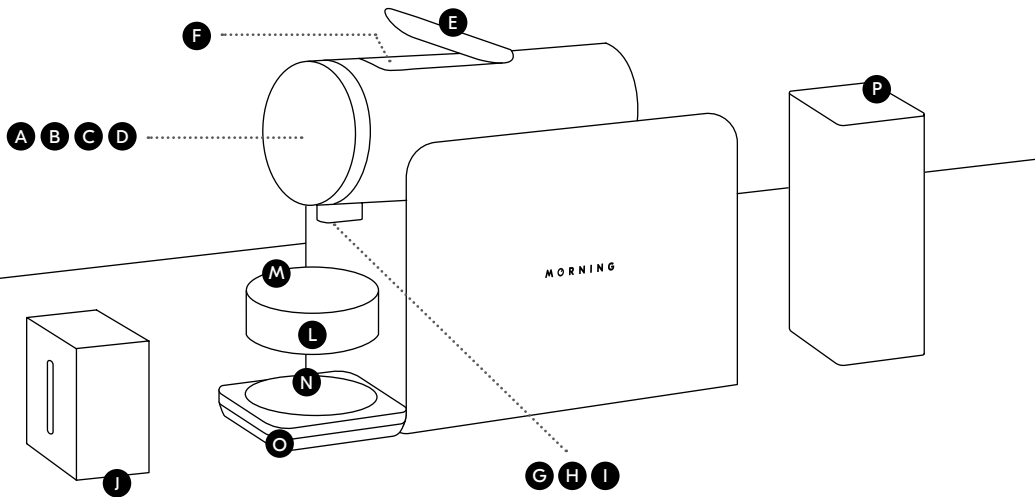

Morning Machine Dial



FUNCTION	ACTION
Scroll Left	Turn Counterclockwise
Scroll Right	Turn Clockwise
Brew/Confirm/Proceed/Next Menu	CONFIRM Button
Back/Cancel	BACK Button
Flush Coffee Outlet	Press & Hold BACK Button (3 Seconds)
Dispense Pre-set Water	Press & Hold CONFIRM Button (3 Seconds)
Turn Dial or Press Any Button	Wake Machine
Enter Machine Settings	Press & Hold the BACK & CONFIRM Buttons

Morning Machine Set Up

Key Indicators

Heating Up In Progress

Heating 93.1°C



Recipe Details

93°C 40.2mL/s
b5 • p5 • p4 • p3

Brewing Details

30.2mL/s 89g

Bloom & Brew

 Pre-Infusion

 Check Water

Clear Capsules

 Blooming 20

 No Cup

 Descaling Required

Brewing In Progress







 Enjoy!

 Wi-Fi

 Server Access

- Check that your home power supply voltage is the same as marked on the Morning Machine box and rating plate.
- Keep the packaging for transporting the Morning Machine in the future.
- You may find a small amount of water in the Morning Machine, due to testing performed at the factory.
- Improper handling of electrical equipment is dangerous and can be deadly. Please pay extra attention to the safety precautions in this manual.

- ① Place the Morning Machine on a stable, flat surface like your kitchen countertop.
- ② Remove the water tank and the used capsule container and drip base for a quick rinse. If you have not used the Machine for a long time, thoroughly rinse.
- ③ Fill in the water tank with fresh filtered water until the MAX line. Do not operate the Machine with an empty tank. The maximum water amount is 850ml.
- ④ Slide the water tank into the water tank base. You should feel it lock into place.
- ⑤ Plug the Morning Machine into the main power source/outlet.
- ⑥ The Morning Machine will automatically switch on.
- ⑦ Please refer to the section Pairing With The Morning Mobile App on page 19 to connect your Machine.

Brewing Your First Cup

If this is your first use or if you have not used the Machine for a prolonged period, please prime the Machine before brewing:

Priming the Machine

- ① Place an empty cup (at least 100ml capacity) under the Morning Machine.
- ② Ensure that the water tank is full.
- ③ Ensure that there is no capsule in the capsule slot.
- ④ Press and hold the back button to purge the Machine.
- ⑤ Repeat the process until water comes out of the coffee spout.

Check and Calibrate Your Scale

You may need to recalibrate your scale to get the most accurate measurements, especially after using the Machine for a long time or moving it around. To do this, you will need a 100g calibration weight.

- ① Go to Machine Settings.
- ② Select Calibration.
- ③ Select Scale Zero.
- ④ Empty the scale then press proceed.
- ⑤ Select Scale Rating then press proceed.
- ⑥ Wait for the success message for all to complete the process.

There are several ways to brew your first coffee capsule on the Morning Machine. Here's the step-by-step process to brew using the Morning Machine's 10 Ready-To-Brew recipes.

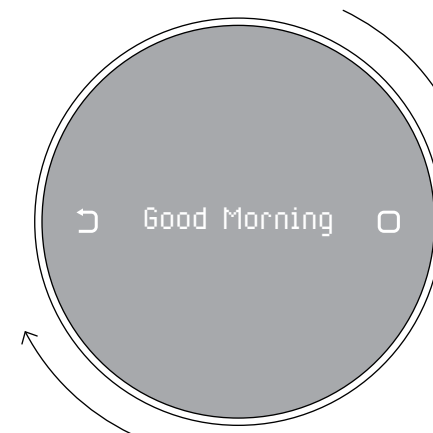

STEP ①

Turn on the Morning Machine by plugging it into a power outlet. Wake the Machine up by turning the dial or by pressing any of the two buttons on the Morning Dial.

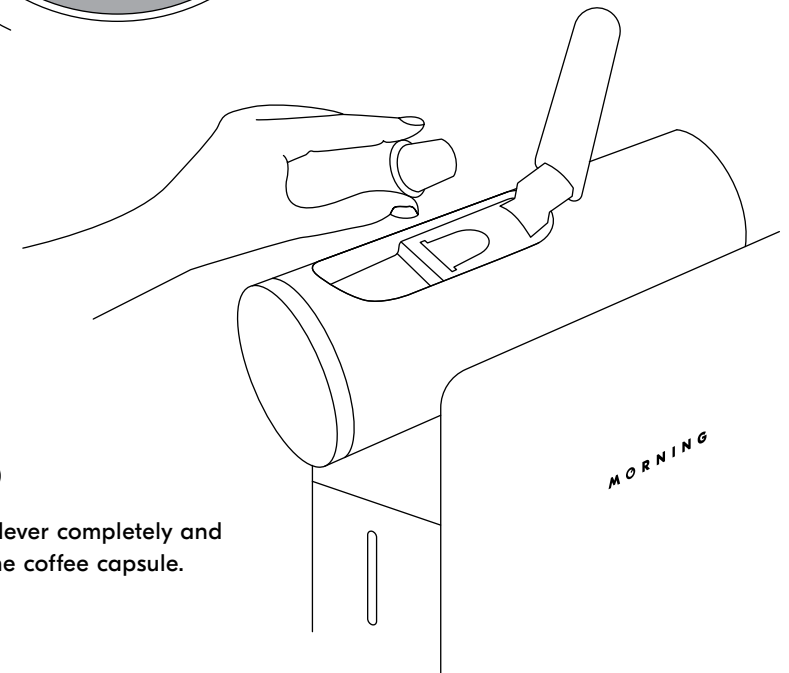

STEP ②

Lift the lever completely and insert the coffee capsule.

STEP ③

Close the lever and place your favourite cup on the drip tray.

If you are using a taller cup or mug, remove the drip tray and place the mug on the scale.

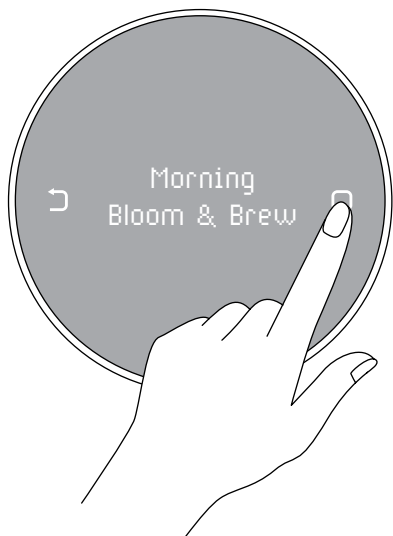
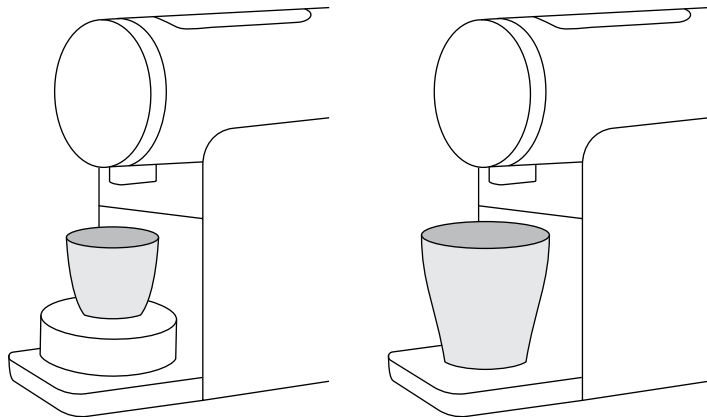

STEP ④

Select a recipe to brew from our Ready-To-Brew recipes.

Press the  CONFIRM button to select and view the recipe.

Press  CONFIRM again to start the brewing process.

Recipe List

RECIPE NAME	DESCRIPTION	COFFEE OUTPUT (in grams)
bb Bloom & Brew	The Morning Machine's flagship recipe, with a built-in Bloom stage (pre-wet/infusion) before the brew. This brews a stronger cup of coffee. There will be a 30-second pause during the Bloom stage.	25g
Short – Dark Roast	A recipe for short, espresso-style coffees. This recipe is suitable for coffees which are medium-dark roasted. These coffees tend to have a syrupy mouthfeel.	25g
Short – Light Roast	A recipe for short, espresso-style coffees. This recipe is suitable for coffees which are lightly roasted. These coffees are tea-like in body and showcase nuanced aromatics and flavour.	45g
Long – Dark Roast	A recipe for a long black coffee, suitable for coffees which are medium-dark roasted. Use this recipe if the capsule is indicated to be enjoyed as a lungo or long coffee.	100g
Long – Light Roast	A recipe for a long black coffee, suitable for coffees which are lightly roasted. Use this recipe if the capsule is indicated to be enjoyed as a lungo or long coffee.	120g
Classic	The most versatile coffee recipe to brew coffees from different origins or roast styles. Literally, it's the perfect shot of coffee.	40g
Short – For Milk	A ristretto-like recipe, suitable for coffees to be enjoyed with some milk. Perfect for your latte or cappuccino.	20g
Mini Filter Brew	A recipe that produces a coffee that is similar to filter-type brewing. This produces a smoother cup of coffee.	50g coffee, 25g by-pass water
Kyoto-style Drip	A 5-minute slow brew recipe if you like to enjoy your coffee over ice. Brew the recipe then add some ice cubes to your cup right after.	100g
Ceremony	Inspired by the Ethiopian Coffee Ceremony, this recipe is in between an espresso and a lungo-type beverage. Perfect for medium to light-roasted coffees.	80g

Compatible Capsule Types

The Morning Machine was built to ensure that it works with Nespresso® OriginalLine capsules and third-party compatible capsules.

The Morning Machine supports Aluminium, Compostable and Plastic (i.e. PBT) coffee capsules.

As compostable capsules may change in form once the brew temperature is applied, we recommend ejecting the coffee capsule immediately after the brewing process to avoid the compostable capsule getting stuck in the chamber.

For the latest set of compatibility information, please visit www.drinkmorning.com.

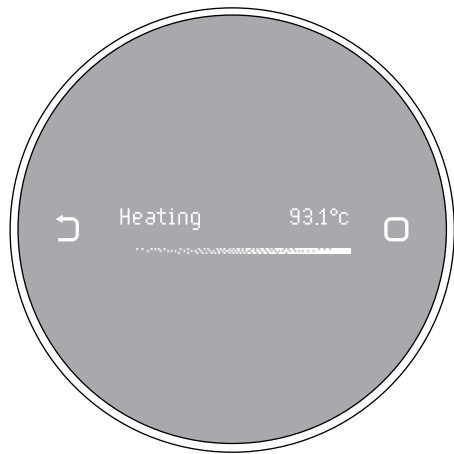

STEP ⑤

The Morning Machine will heat up based on the recipe temperature setting.

STEP ⑥

The brewing process will commence and then show you a progress meter until it is complete.

STEP ⑦

After the brew, remove the cup and lift the lever to dispose of the spent coffee capsule.



If you wish to make changes or create your own recipes, you can with the Morning Mobile App. Please refer to the instructions on page 22. You can also download the instructions via www.drinkmorning.com.

Brewing Tips

Tip ①

Shaking the coffee capsule before use. This ensures an even distribution of the coffee grounds inside the capsule, allowing the Machine to extract the coffee's full potential.

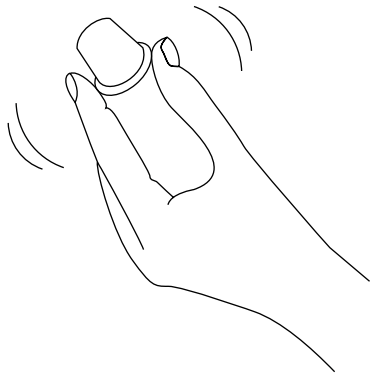

Tip ②

Press & hold the  BACK button for 3 seconds to run water through the Machine. It helps warm up the Machine and clean the brew unit to achieve the best cup of coffee possible.

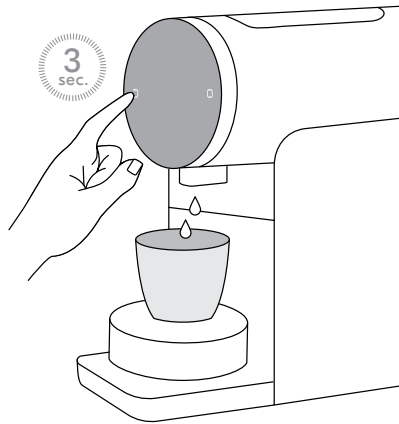

Tip ③

We recommend using filtered water for the Morning Machine. You can check your existing water hardness by going to **SETTINGS > MACHINE INFO > TDS**.

Tip ④

Press & hold the  BACK button for 3 seconds to flush the coffee spout/outlet after the brew for a quick rinse.

Tip ⑤

The Bloom & Brew function can be applied to any recipe you create via the Morning app.

Pairing With The Morning Mobile App

To benefit from all the Morning Machine features, we recommend pairing your Machine with your smartphone.

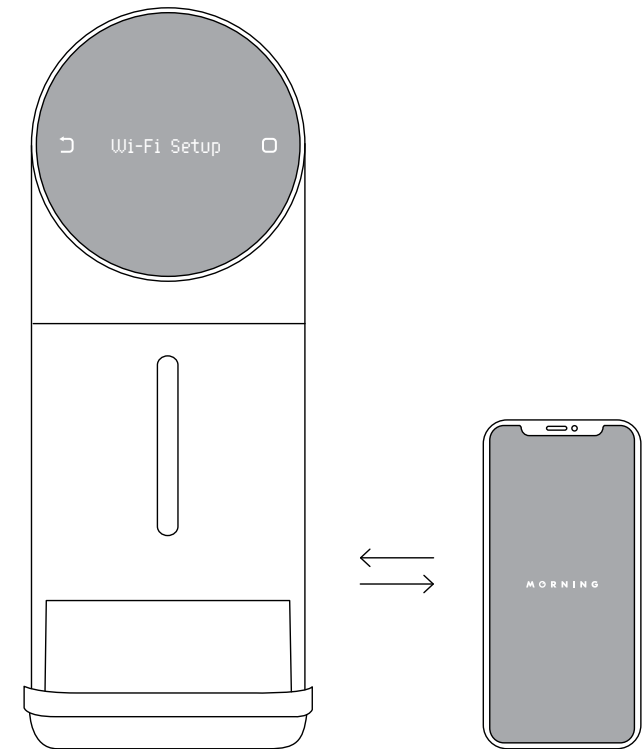





- You will need a local Wi-Fi connection to proceed with this section.
- Please remember to switch on your Bluetooth on your smartphone before proceeding.
- Please visit www.drinkmorning.com to check your smartphone's compatibility.

How To Pair



- ① Download the Morning Mobile App from the Apple App Store or the Google Play Store. Search for "DrinkMorning".



- ② Check that your phone's Bluetooth is switched on, then launch the Morning App.
- ③ On your Morning Machine, enter the Machine Settings by holding down both the  BACK and  CONFIRM buttons.
- ④ Enter the Settings page, then go to Set Up Wi-Fi and press the  CONFIRM button.
- ⑤ The Morning Machine will display "Configure On App".
- ⑥ Back on the Morning App, click the Machine icon on the top right hand corner of the Recipes page.
- ⑦ Click on the New Machine button.
- ⑧ When you see your Machine on screen, click Connect.
- ⑨ Select your local Wi-Fi network name, SSID and the password. Press Save Wi-Fi Details.
- ⑩ Voila! Your Machine is connected to Wi-Fi and paired with your app. The Morning Machine will display "Setup Complete".
- ⑪ Once connected successfully, your machine will show "Connected to Cloud" on the Coffee Machine page and display a blue circle icon.
- ⑫ The Morning Machine will display the  Wi-Fi icon and also the  Server Access icon on the OLED screen when connected.

Reconnecting the Machine to a different or new Wi-Fi Network or accessing the Wi-Fi Settings on the Morning Mobile App

This process is required if you have previously paired your Morning Machine via the Morning Mobile App with a local network, and then wish to pair it to a different Wi-Fi Network. Also, you can follow these steps prior when you wish to access the Wi-Fi Settings on the Morning Mobile App.

- ① On your Morning Machine, enter the Machine Settings by holding down both the  BACK and  CONFIRM buttons.
- ② Enter the Settings page, then go to Set Up Wi-Fi and press the  CONFIRM button.
- ③ The Morning Machine will display "Configure On App".
- ④ Back on the Morning App, click the Machine icon on the Recipes page.
- ⑤ Select the Machine that you intend to access and connect to the cloud.
- ⑥ Click on Machine Settings and then click on Wi-Fi Settings.
- ⑦ Select your new Wi-Fi network name and enter the password.
- ⑧ Once connected successfully, your machine will show "Connected to Cloud" on the Coffee Machine page and display a blue circle icon.

Brewing A Roaster Recipe



The Morning Mobile app has a database of our partner roasters plus a growing list of Nespresso® OriginalLine capsules and third-party compatible capsules.

Once you have your capsule to brew, insert the capsule into the Morning Machine.

Open the Morning Mobile App, click the Roasters tab or the Others tab to look for the coffee roaster. Select the recipe to preview it.

When it is confirmed, place your cup on the drip tray and press the 'Brew Coffee' button on the Morning Mobile app.

A progress meter will show on both the Morning Machine and the Morning Mobile app.

Creating Your Own Recipes

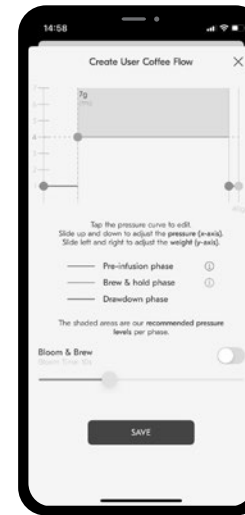

With the Morning Mobile app, you can create your own recipes that suit your preferences. You can save your recipes on the Morning Machine or on the app for easy brewing.

Open the Morning Mobile app on your smartphone, then click the Brew tab to create your recipes.

For detailed instructions on creating your recipe, please visit www.drinkmorning.com.

Eco Mode

The Morning Machine is equipped with an Eco Mode feature for energy saving purposes.

The Morning Machine will automatically turn into Eco Mode after 10 minutes. To wake the Machine up, scroll the dial or touch any of the on-screen buttons.

To adjust the Eco Mode timing, you may change the settings under the Machine Settings.

Cleaning & Maintenance

- Never immerse the Morning Machine or part of it in water.
- Be sure to unplug the Machine before cleaning.
- Do not use any strong cleaning agent or solvent cleaner.
- Do not use any sharp objects, brushes or sharp abrasives.
- Do not place the Morning Machine in the dishwasher.

Daily Cleaning

We recommend emptying the Used Capsule Container and the drip tray every day.

- ① Raise the lever to ensure that there is no capsule inside the chamber.
- ② Remove the drip tray from its position.
- ③ Remove the Used Capsule Container and the Used Capsule Drip Base.
- ④ Rinse both with fresh water.
- ⑤ Remove the Water Tank & lid to rinse under fresh water.
- ⑥ Dry all the parts with a fresh and clean towel, cloth or paper towel.
- ⑦ Clean the Coffee Outlet and the Water By-pass Outlet regularly with a damp cloth.

Brew Unit Maintenance

We recommend using cleaners like the Cafetto Eco Capsule Clean (for Nespresso®) or the Caffenu Eco Cleaning Capsules (for Nespresso®) at least once a month, depending on your usage. This process reduces the risk of Machine break-down that can occur as a result of blockages.

- ① Insert one Capsule Clean capsule into the Morning Machine and close the lever.
- ② Ensure that the water tank is full of freshwater with an empty cup under the Coffee Outlet.
- ③ Go to **MACHINE > SETTINGS > MAINTENANCE** on the Morning Machine.
- ④ Run the Stage 1 maintenance program and follow on-screen instructions.
- ⑤ Eject the capsule into the waste compartment.
- ⑥ Continue stage 2 to rinse the brew unit.
- ⑦ Your capsule Machine is now clean and once again ready for making delicious coffee!

Troubleshooting

Descaling

We recommend descaling the Morning Machine at least once a year. The Morning Machine will prompt you to descale the machine after 600 cups.

You may use existing descaling products in the market, such as the Nespresso® Descaling Kit or the Caffenu® Descaling Kit.

- ① Descale the Morning Machine when the Machine is prompting you to descale (after 600 cups).
- ② Lift and close the lever to eject the spent capsule into the Used Capsule Container.
- ③ Empty the Used Capsule Container.
- ④ Fill the water tank with fresh, filtered water, up to 0.5L.
- ⑤ Add 1 sachet of your descaling liquid/solution of choice into the water tank.
- ⑥ Remove the Drip Tray and place a container (minimum volume of 1L) under the Coffee Outlet.
- ⑦ Go to **MACHINE > SETTINGS > MAINTENANCE** on the Morning Machine.
- ⑧ Run the Stage 1 maintenance program and follow on-screen instructions.
- ⑨ Run the Stage 2 maintenance program and follow on-screen instructions.
- ⑩ If you need to refill the water tank during the process, fill until the MAX level.
- ⑪ The Machine will show when the descaling is completed.
- ⑫ During the decalcifying process, if you need to empty your container under the Coffee Outlet, you may pause by pressing the  **BACK** button.

PROBLEM	CAUSE	SOLUTION
No coffee is brewed.	The water tank is empty.	Fill the water tank with water until the MAX level.
The coffee is not hot enough.	Cup or mug might be cold.	Preheat your cup or mug.
	Low temperature set for the recipe.	Set the ideal brew temperature for your recipe.
	Scale build-up in the Machine.	Perform a descaling procedure.
Spent capsule did not drop down after raising the lever.	The Used Capsule Container is full.	Empty the Used Capsule Container.
	The spent capsule is deformed after brewing.	Use a teaspoon to remove the stuck capsule from the brew chamber. Do not use a sharp object. The brew chamber may leak if damaged or scratched.
There is steam when the lever is raised.	The lever is raised too quickly after brewing.	Let the residual pressure escape for a few seconds before raising the lever.
There is water on your countertop.	The water tank is leaking.	Check the valve in the water tank to ensure that it is not stuck when removed. Check if the tank is seated fully in place in the Machine.
	Drip Tray is full of water.	Empty the drip tray.

Technical Specifications

PROBLEM	CAUSE	SOLUTION
Occasional drops of water/Coffee out of the Coffee Outlet/ Water By-pass Outlet.	The heater is being kept warm.	This is normal behaviour and not a defect.
Coffee comes out in drips from the Coffee Outlet or drips back into the Used Capsule Container.	The ground coffee inside the capsule might be too fine for water to pass.	<p>Some roasters are grinding finer for coffee capsules. This is acceptable.</p> <p>Dripping is acceptable at the Coffee Outlet, as long as there is no backpressure and causing leakage into the Used Capsule Bin.</p> <p>Select a recipe for light roasted coffee or finely ground coffee capsules via the Morning app.</p>
The pump is running but no water/coffee is coming out.	There may be air bubbles present in the water passageway in the Machine.	<p>On your Machine, make sure your water tank is full and that there is no capsule in the Machine chamber.</p> <p>Then press and hold the back button to trigger the Machine to purge water. Repeat this process until water comes out from the coffee spout.</p>

Size & Weight	40.2cm (L) × 10.2cm (W) × 25.5cm (H), 4.5kg
Adjustable Cup Height	15cm (with drip tray), 25cm (without drip tray)
Water Tank Capacity	850ml
Used Capsule Bin Capacity	8-10 capsules
OLED Screen	1.44 inches
OLED Interface	128×32 Display
Buttons and Interactions	2 Capacitive Buttons Rotatable Dial Selection Wheel
Electricity	AC220-240V 50-60Hz 1200-1300W; AC120V 60Hz 1250W
Pump	20 MPa, 120V, 60Hz or 230V, 50Hz
Max Pressure	20 bar
Pressure Control	3 stages, 7 levels
Output Control	1g steps 1g~250g
Temperature Control	75°C-98°C, in 1°C increments
Connectivity	Wi-Fi & Bluetooth
Capsule Compatibility	Nespresso® OriginalLine capsules and third-party compatible capsules
Mobile App	Works with iOS devices running version 10.0 and later, and Android devices running version 5.0 and later.

Reset Machine Settings

You may reset your *Morning Machine* to remove all the user data and settings by following the steps below.

- ① Go to **MACHINE > SETTINGS**
- ② Select Machine Setting Reset
- ③ Press  **CONFIRM**

When you reset the Machine, the following happens:

- All your created recipes are deleted from the Machine.
- All default recipes gets reloaded into the Machine.
- The Wi-Fi connection settings are removed.
- The total Brew Count is set back to zero.

Warranty Information

Akronym Pte. Ltd. ('Akronym') warrants this product against defects in materials and workmanship for a period of one year from the date of purchase. Official receipts shall serve as proof of purchase.

During this period, Akronym will either repair or replace, at its discretion, any defective product at no charge to the owner. Replacement products or repaired parts will be guaranteed for only the unexpired portion of the original warranty or six months, whichever is greater. This limited warranty does not apply to any defect resulting from accident, misuse, or any other reason beyond Akronym's reasonable control, including but not limited to: normal wear and tear, negligence or failure to follow the product instructions, improper or inadequate maintenance, calcium deposits or descaling, connection to improper power supply, unauthorised product modification or repair, use for commercial purposes, fire, lightning, flood or other external causes.

This warranty is valid only in the country of purchase or in such other countries where Akronym sells or services the product.

This limited warranty shall be the full extent of Akronym's liability however caused. Except to the extent allowed by applicable law, the terms of this limited warranty do not exclude, restrict or modify the mandatory statutory rights applicable to the sale of this product and are in addition to those rights.

If you believe your product is defective, please email hello@drinkmorning.com for instructions on where to send or bring it for repair.

Akronym Pte. Ltd.
240 Macpherson Road, #02-02
Singapore 348574



DRINKMORNING.COM